

## Magnetic Water Treatment

---

### 1. Company Information

---

#### 1.1 Brochures

---

#### 1.2 Technical Information

---

#### 1.3 Basic Principles

---

#### 1.4 Application Possibilities

---

#### 1.5 References

---

#### 1.6 Various

---

#### 1.7 Product Information

---

### 2. Small AU-Unit cut through

---

### 3. Magnetic Particle Strainer

## Aqua Unique

### Denmark

Aqua Unique  
Neptunvej 2  
DK-8723 Loesning

Phone + 45 75 89 99 99

Mobil + 45 28 19 96 99

E-mail [info@aquaunique.dk](mailto:info@aquaunique.dk)

<http://www.aquaunique.dk>

## Standard AU Scale Control program

Standard program for protection against build-up of lime scale and to removal of existing lime scale deposits in water installations. In addition, the system initiates the formation of protective oxides, which form a protective layer in pipelines, preventing corrosion. Normally used in: domestic houses, blocks of flats, industrial applications and specific applications etc.

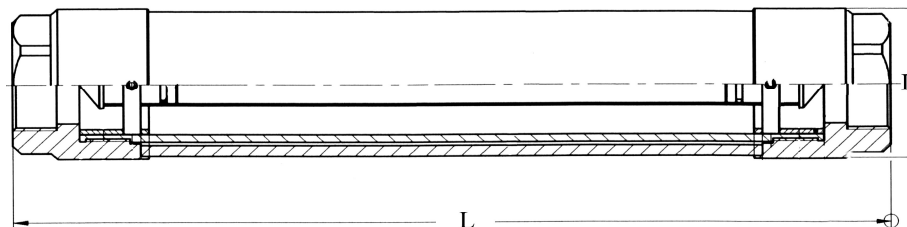

### Aqua Unique® – Domestic unit

Water temp. max. 40° C

VVS no.	Model	Connection		Capacity		Dimension L x D	Weight kg
		DN	Inch	l/min.	max. m³/h.		
399952.006	AU 20-35 CW	20	¾	0,5 – 35	2,1	250 x 53	1,8

### Aqua Unique® – Domestic / Industrial units.

Water temp. max. 100° C

VVS no.	Model	Connection		Capacity		Dimension L x D	Weight kg
		DN	Inch	l/min.	max. m³/h.		
399952.006	AU 20-35 CW	20	¾	0,5 – 35	2,1	250 x 53	1,8
VVS no.	Model	Connection		Capacity		Dimension L x D	Weight kg
		DN	Inch	l/min.	max. m³/h.		
399953.024	AU 15 - 8	15	½	0,1 - 8	0,5	184 x 43	1.3
399953.034	AU 15 - 15	15	½	0,5 - 15	0,9	199 x 53	1.4
399953.036	AU 20 - 45	20	¾	0,5 - 45	2,7	292 x 53	2.0
399953.038	AU 25 - 65	25	1	0,5 - 65	3,9	296 x 53	2.1
399953.040	AU 32 - 135	32	1¼	19 - 135	8,1	356 x 78	4.9
399953.041	AU 40 - 245	40	1½	25 - 245	14,7	418 x 78	6.5
399953.042	AU 50 - 385	50	2	40 - 385	23,1	448 x 93	7.8

### Product Information:

Materials:

Connections:	Female thread (DN), stainless steel
Inner pipe:	Stainless steel, type SAF 2304
Magnet tubes:	Titanium
Cover:	PVC - red
Magnets:	Neodym, max. energy loss: 0.2 % / 10 years
O-rings:	EPDM

Technical Specifications:

Working pressure:	10 bar
Test pressure:	16 bar
Connections:	Female thread (DN)
Installation:	Vertical or horizontal

NB: Strainer AU MPS: Water contains magnetite, rust and iron particles. A magnetic particle strainer (AU MPS) shall be installed into the pipe system in front of the Aqua Unique® unit, in order to protect the magnet system.

To prevent pressure loss, the filter and the magnet should be cleaned.

## Standard AU Scale Control program FL

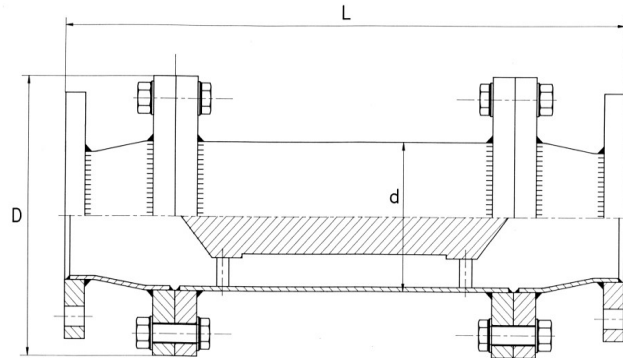

Standard program for protection against build-up of limescale and to removal of existing limescale deposits, in water installations. In addition, the system initiates the formation of protective oxides, which form a protective layer in pipelines, preventing corrosion. Normally used in: big blocks of flats, industrial applications, cooling applications and water works etc..

### Aqua Unique® - AU FL – Industrial units

Water temp. max. 100° C

VVS no.	Model	Connection		Capacity		Dimension L x D x d	Weight kg
		DN	Inch	l/min.	max. m³/h.		
399957.013	AU 65- 550 FL	65	2½	150 - 550	33,0	560 x 220 x 108	34
399957.014	AU 80- 720 FL	80	3	225 - 720	43,2	560 x 220 x 114	36
399957.016	AU 100- 905 FL	100	4	305 - 905	54,3	615 x 250 x 133	48
399957.017	AU 125- 1405 FL	125	5	375 - 1405	84,3	530 x 250 x 140	26
399957.018	AU 150- 1960 FL	150	6	510 - 1960	117,6	530 x 285 x 159	37
399957.020	AU 200- 6340 FL	200	8	1810 - 6340	380,4	534 x 340 x 219	81
399957.022	AU 250 - 10580 FL	250	10	3025 - 10580	634,8	564 x 405 x 273	95
399957.023	AU 300 - 15875 FL	300	12	4535 - 15875	952,5	734 x 460 x 324	146
399957.024	AU 350 - 19570 FL	350	14	5590 - 19570	1174,2	742 x 520 x 368	172

### Product Information:

#### Materials:

House:	Galvanised steel, (painted red)
Magnet tube/parts:	Stainless steel
Magnets:	Neodym, max. energy loss: 0.2 % / 10 years
O-rings:	EPDM

#### Technical Specifications:

Working pressure:	10 bar
Test pressure:	16 bar
Connections:	Flanges, DN 65 - DN 100 : DIN 2576B Flanges, DN 125 - DN 350 : DIN 2633
Installation:	Vertical or horizontal

#### Notes:

Stainless steel:	The complete range is available in stainless steel.
Special applications:	Units can be delivered to customer specification.

#### NB:

Strainer AU MPS: Water contains magnetite, rust and iron particles. A magnetic particle strainer (AU MPS) or magnet filter shall be installed into the pipe system in front of the Aqua Unique® unit, in order to protect the magnet system.  
To prevent pressure loss, the filter and the magnet should be cleaned.

### Pressure loss curve AU 20-35 CW

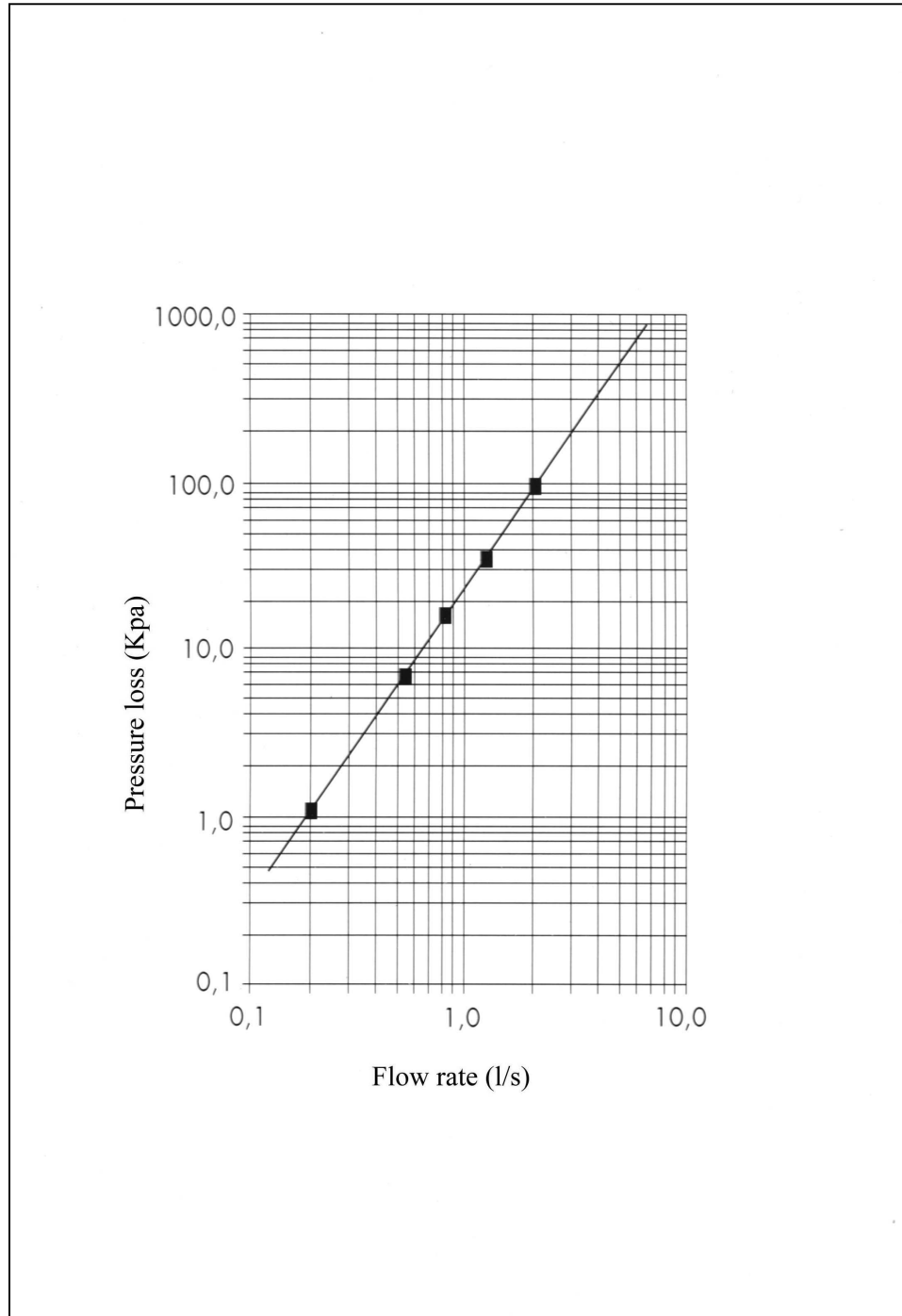

### Pressure loss curve AU 20-45 HW

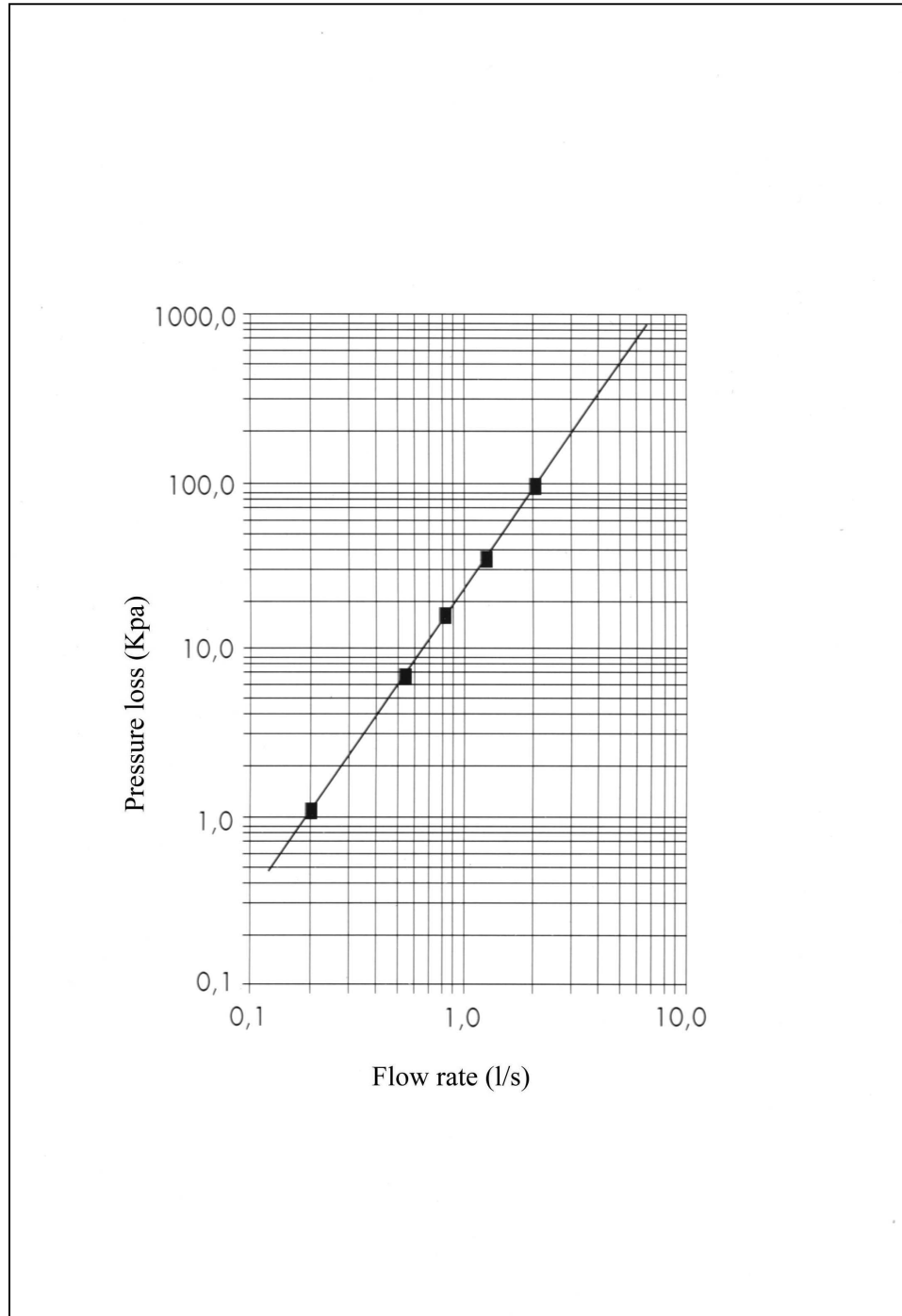

### Pressure loss curve AU 25-65 HW

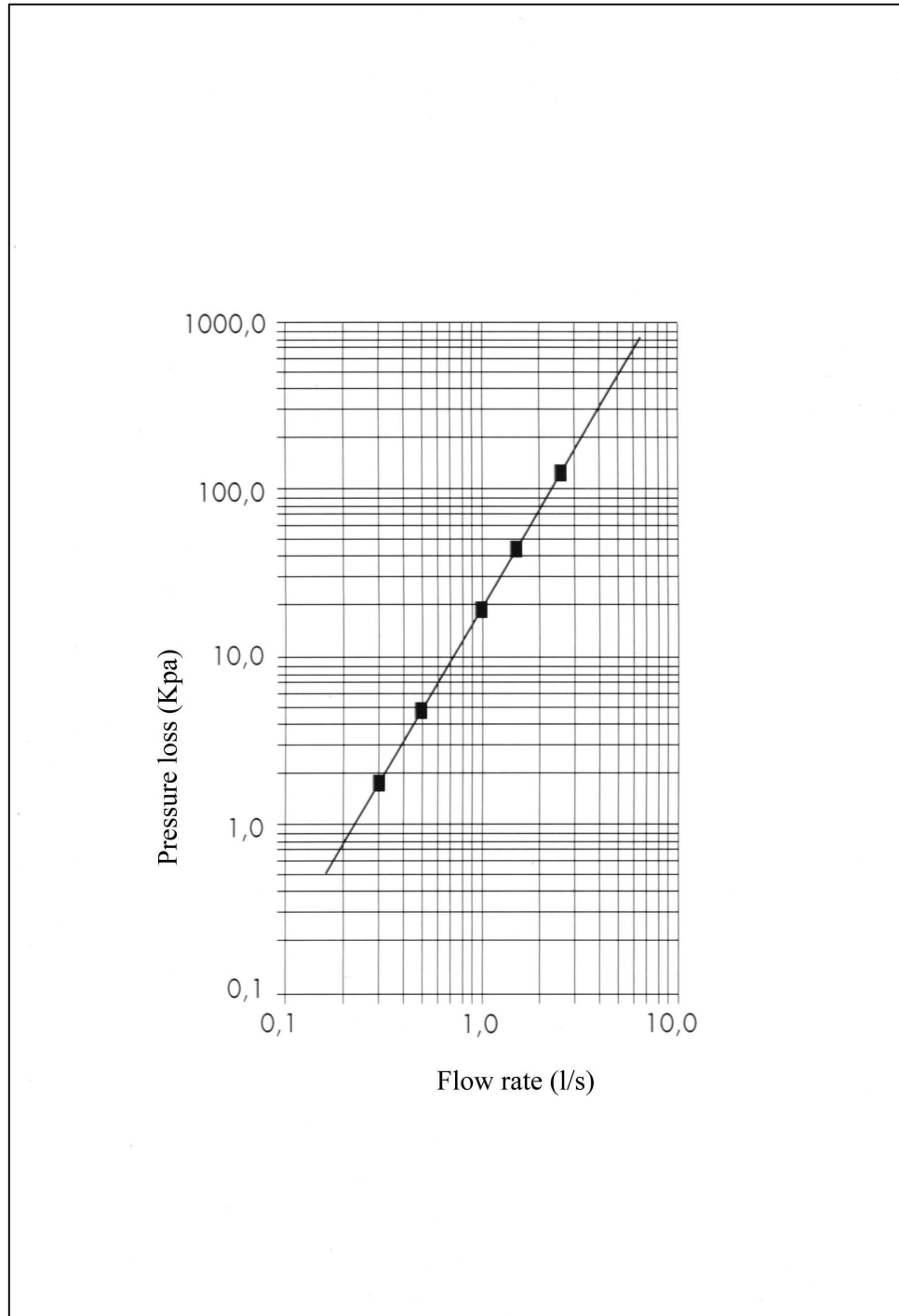

Pressure loss curve  
AU 32-135 HW

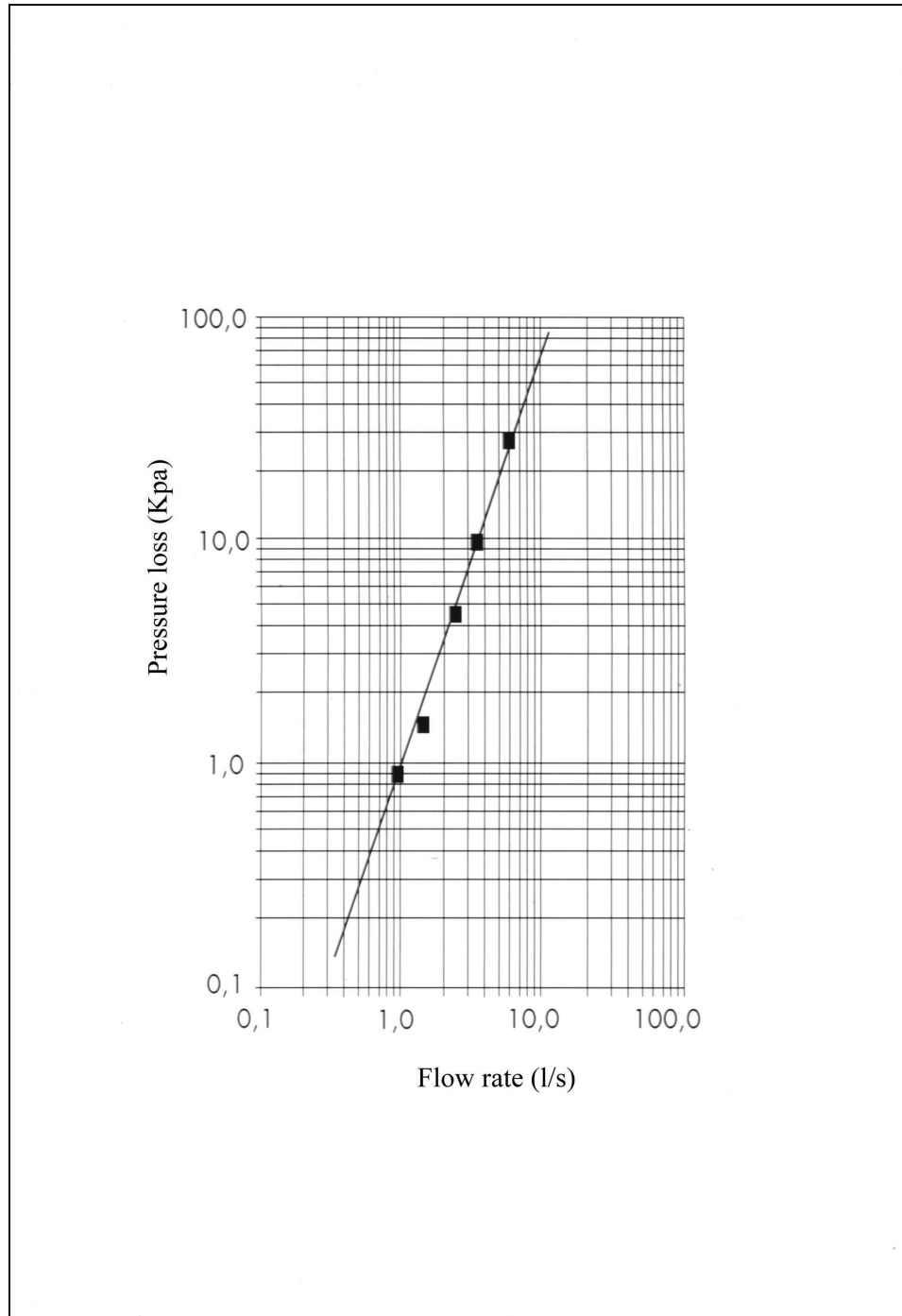



Pressure loss curve  
AU 40-245 HW

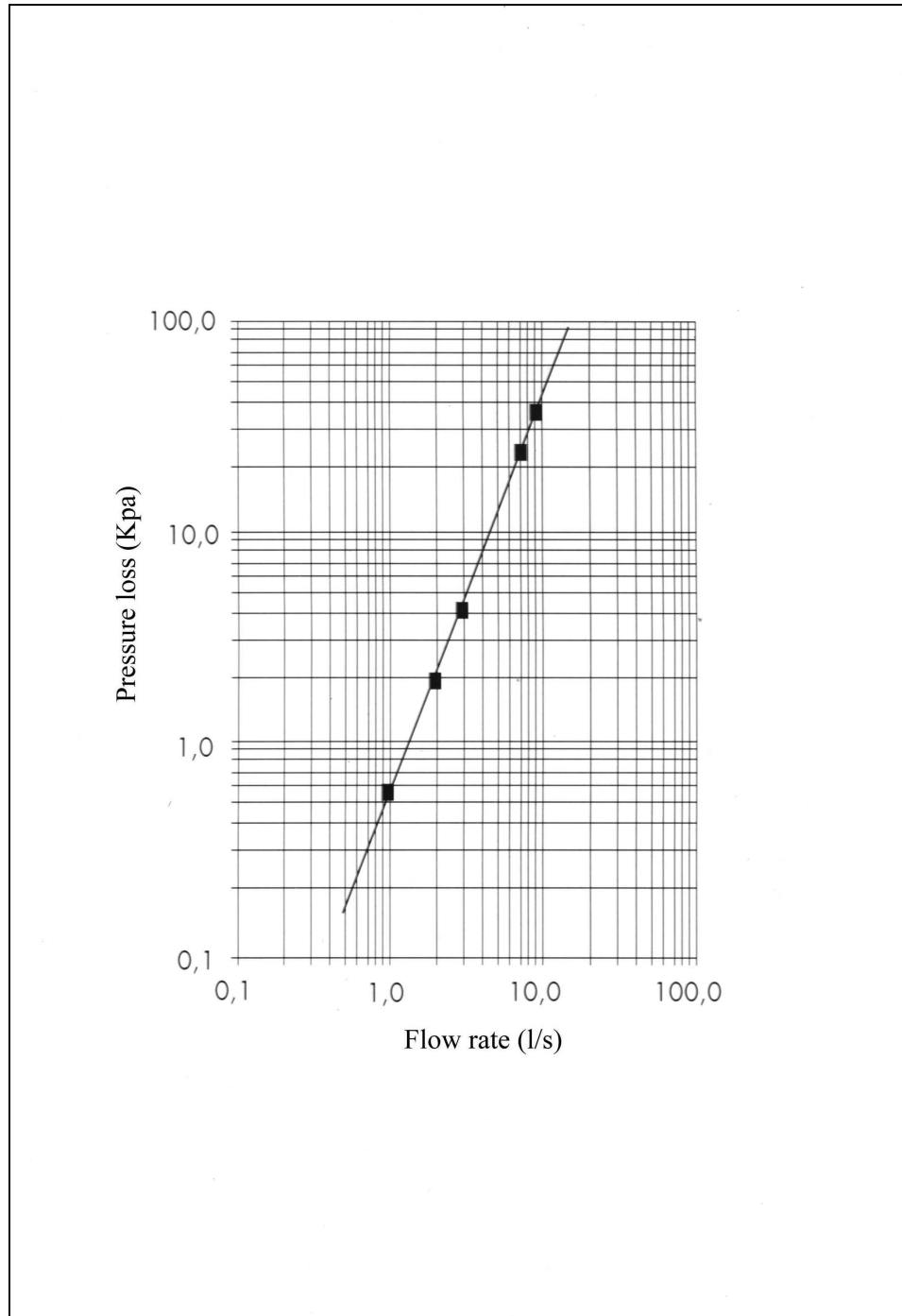

### Pressure loss curve AU 50-385 HW

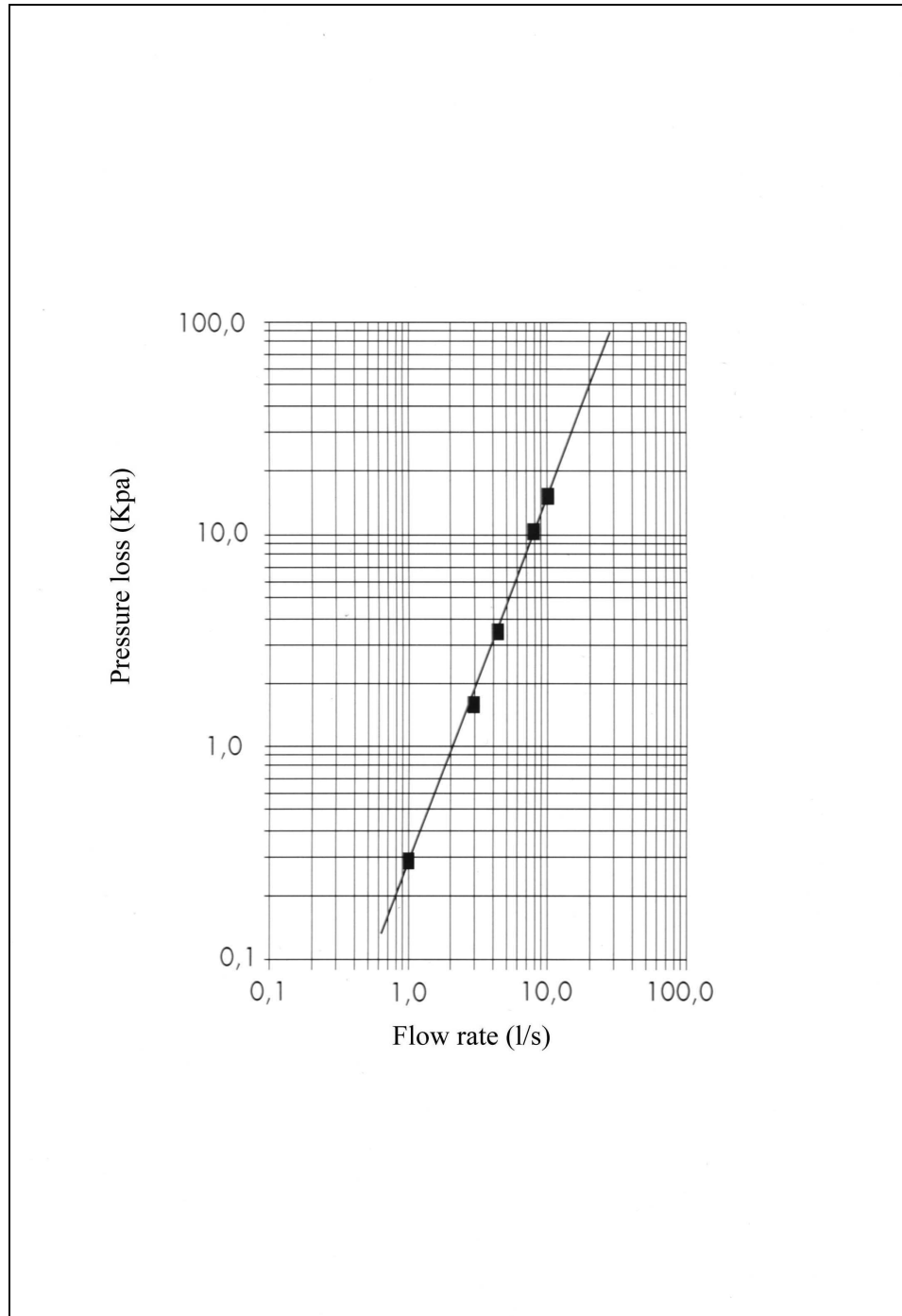

## Water flow calculation

1. Determine the maximum flow rate for the installation to be protected:
  - a) The max. flow rate within a short period of time: l/min - l/h - m<sup>3</sup>/h
  - b) The max. flow rate within a certain period of time: m<sup>3</sup>/day - m<sup>3</sup>/week
2. Determine the average flow rate for the installation to be protected:  
Calculate the average flow rate (see table 1.2.23).  
Read the water meter during a 24-hour period and calculate the average flow rate.

In order to obtain an accurate water flow rate in apartment blocks and larger housing estates, we recommend that the boilerman/caretaker reads the water meter at specific periods throughout the day, i.e. 6 am, 7 am, 8 am, 11.30 am, 1 pm, 4 pm, 5 pm, 6 pm, 7 pm.

P.S.: Please re-check the results, as measurement errors are very common.

The max. capacity of the magnetic water treatment system should cover the maximum flow rate.

The min. capacity of the magnetic water treatment system should cover the average flow rate.

NB: The size of the Aqua Unique® water treatment unit should not be calculated based solely on the size of the pipeline.

## Pumps

1. The pump capacity is very important when calculating the type of magnetic water treatment unit to be installed. The capacity of the water treatment unit should correspond with the capacity of the pump, e.g. the capacity of a booster pump installed to a cold water inlet will determine the size of the water treatment unit.
2. In addition, a magnetic water treatment unit should always be installed to the pressure side of the hot water circulation pump. The size of the unit is determined by the capacity of the hot water circulation pump.

NB: The capacity is usually printed upon the pump, otherwise the manufacturer can provide this information.

**When installing a magnetic water treatment system, it should always be installed to the pressure side of the pumps, e.g.:**

**Booster pumps**

**Hot water circulation pumps**

- **Suction pumps**

NB: The only exception is when the exclusive purpose is to protect the pump itself, i.e.:

- To avoid limescale build-up in booster pumps, when a constant water pressure is to be maintained in a production plant.
- To avoid limescale build-up in suction pumps.
- To avoid limescale build-up in vacuum pumps.

Tab. 1

The Aqua Unique® magnetic water treatment system can be calculated by using the outlet flow rates from the European DIN 1988. The table should be adapted to national standards if the water flow varies greatly from the following table (DIN 1988):

<b>Min. Pressure (bar)</b>	<b>Type of tap</b>	<b>Dimension</b>	<b>Cold l/s</b>	<b>Hot l/s</b>	<b>Totals l/s</b>
0.5	Tap valve	DN 15			0.30
0.5	Tap valve	DN 20			0.50
0.5	Tap valve	DN 25			1.00
1.0	Shower	DN 15	0.10	0.10	0.20
1.0	Bath tap	DN 15	0.15	0.15	0.30
1.0	Kitchen tap	DN 15	0.07	0.07	0.14
1.0	Wash basin	DN 15	0.07	0.07	0.14
1.0	Bidet	DN 15	0.07	0.07	0.14
0.5	WC - DIN 19542	DN 15			0.13
1.2	Flush valve/WC – DIN 3265 / 1	DN 15			0.70
1.2	Flush valve/WC – DIN 3265 / 1	DN 20			1.00
0.4	Flush valve/WC – DIN 3265 / 1	DN 25			1.00
1.0	Flush valve/Urinal	DN 15			0.30
1.0	Washing machine	DN 15			0.25
1.0	Dishwasher	DN 15			0.15

The following table (Table 2) should be adapted to national standards if high variations occur.

- $Q_S$  represents the total flow rate.
- $Q_B$  represents the calculated average flow rate.

$Q_S$	$Q_B$	$Q_S$	$Q_B$	$Q_S$	$Q_B$	$Q_S$	$Q_B$
0.06	0.05	43.06	3.05	711	6.05	4049	9.05
0.10	0.10	46.08	3.10	736	6.10	4195	9.10
0.15	0.15	49.04	3.15	762	6.15	4296	9.15
0.21	0.20	52.15	3.20	789	6.20	4403	9.20
0.29	0.25	56.41	3.25	817	6.25	4510	9.25
0.38	0.30	58.83	3.30	845	6.30	4619	9.30
0.48	0.35	62.41	3.35	874	6.35	4730	9.35
0.60	0.40	66.17	3.40	904	6.40	4843	9.40
0.72	0.45	70.10	3.45	935	6.45	4958	9.45
0.87	0.50	74.21	3.50	966	6.50	5076	9.50
1.03	0.55	78.51	3.55	999	6.55	5195	9.55
1.20	0.60	83.01	3.60	1032	6.60	5314	9.60
1.39	0.65	87.71	3.65	1066	6.65	5441	9.65
1.59	0.70	92.62	3.70	1101	6.70	5567	9.70
1.81	0.75	97.14	3.75	1137	6.75	5696	9.75
2.04	0.80	103.08	3.80	1174	6.80	5827	9.80
2.29	0.85	108.65	3.85	1212	6.85	5960	9.85
2.55	0.90	114.45	3.90	1250	6.90	6096	9.90
2.83	0.95	120.50	3.95	1290	6.95	6234	9.95
3.13	1.00	126.79	4.00	1330	7.00	6375	10.00
3.45	1.05	133	4.05	1372	7.05	6510	10.05
3.78	1.10	140	4.10	1415	7.10	6668	10.10
4.12	1.15	147	4.15	1459	7.15	6811	10.15
4.49	1.20	155	4.20	1503	7.20	6962	10.20
4.87	1.25	162	4.25	1549	7.25	7118	10.25
5.28	1.30	170	4.30	1596	7.30	7272	10.30
5.68	1.35	178	4.35	1644	7.35	7480	10.35
6.11	1.40	187	4.40	1693	7.40	7592	10.40
6.58	1.45	196	4.45	1744	7.45	7758	10.45
7.03	1.50	205	4.50	1795	7.50	7923	10.50
7.51	1.55	215	4.55	1848	7.55	8093	10.55
8.02	1.60	225	4.60	1902	7.60	8266	10.60
8.54	1.65	235	4.65	1957	7.65	8441	10.65
9.08	1.70	246	4.70	2014	7.70	8620	10.70
9.63	1.75	257	4.75	2071	7.75	8801	10.75
10.21	1.80	268	4.80	2130	7.80	8986	10.80
10.80	1.85	280	4.85	2191	7.85	9174	10.85
11.41	1.90	292	4.90	2252	7.90	9364	10.90
12.04	1.95	305	4.95	2315	7.95	9558	10.95
12.69	2.00	318	5.00	2380	8.00	9756	11.00
13.38	2.05	331	5.05	2448	8.05	9955	11.05
14.06	2.10	345	5.10	2513	8.10	10158	11.10
14.78	2.15	360	5.15	2582	8.15	10365	11.15
15.48	2.20	374	5.20	2652	8.20	10575	11.20
16.23	2.25	390	5.25	2723	8.25	10788	11.25
16.99	2.30	406	5.30	2797	8.30	11005	11.30
17.78	2.35	422	5.35	2871	8.35	11225	11.35
18.58	2.40	439	5.40	2948	8.40	11448	11.40
19.40	2.45	456	5.45	3026	8.45	11675	11.45
20.24	2.50	474	5.50	3105	8.50	11906	11.50
21.89	2.55	498	5.55	3186	8.55	12140	11.55
23.54	2.60	512	5.60	3269	8.60	12378	11.60
25.28	2.65	531	5.65	3354	8.65	12619	11.65
27.13	2.70	552	5.70	3440	8.70	12865	11.70
29.08	2.75	572	5.75	3528	8.75	13113	11.75
31.15	2.80	594	5.80	3618	8.80	13368	11.80
33.32	2.85	616	5.85	3709	8.85	13623	11.85
35.62	2.90	639	5.90	3803	8.90	13883	11.90
38.04	2.95	662	5.95	3896	8.95	14147	11.95
40.58	3.00	686	6.00	3995	9.00	14416	12.00

## Method of Calculation

1. Fill in the flow rates of each individual tap (Tab. 1).
2. Calculate the flow rate for one flat (A).
3. Fill in the number of flats (B).
4. Multiply the total flow rate (A) with the number of flats (B) -  $A \times B = Q_S$ .
5. Look in Tab. 2. for the total flow rate ( $Q_S$ ) and simply read the average flow rate ( $Q_B$ ).
6. Calculate the flow rate in l/min to determine the size of the magnetic water treatment system  $Q_B \times 60 = \text{l/min.}$
7. Determine the size of the magnetic water treatment unit. The maximum capacity of the magnetic water treatment unit should be well in excess of the average flow rate (l/min).

Taps	Flow rate - l/s		Totals
	Cold	Hot	
Tap valve			
Shower			
Bath tap			
Kitchen tap			
Wash basin			
Bidet			
WC			
Washing machine			
Dishwasher			
	<b>Equations</b>	<b>Calculations</b>	<b>Totals</b>
Flow rate pr flat - l/s	A		
Total flats	B		
Total flow rate - l/s	$Q_S = A \times B$		
Average flow rate - l/s	$Q_B$		
Average flow rate - l/min	$Q_B \times 60$		

## Basics - Water

Clean water is a clear, odourless and taste free liquid. Water solidifies at 0° C, and boils at 100° C. The Celsius temperature scale is defined by the freezing and boiling point of water. Water has its greatest density at 1,000.000 g/cm<sup>3</sup> - at 4° C, while at 25° C it is 0.997037 g/cm<sup>3</sup>, and at 0° C - 0.9168 g/m<sup>3</sup>. The following table illustrates the physical characteristics of water compared to other substances.

Substance	Solidifying point - °C	Boiling point - °C
H <sub>2</sub> O	0.0	100.0
H <sub>2</sub> S	-85.5	-60.7
H <sub>2</sub> Se	-60.4	-41.5
H <sub>2</sub> Te	-49.0	-2.0

Tab. 1: Waters freezing and boiling points in relation to comparative substances.

The molecular structure of liquid water determines the characteristics shown above. The molecular structure of water was first proposed in 1933 by J.D. Bernal and R.H. Fowler - a theory which is still acknowledged in modern times. It was described as consisting of netish and ice-like water molecules - referred to as "Clusters" (Fig. 1).

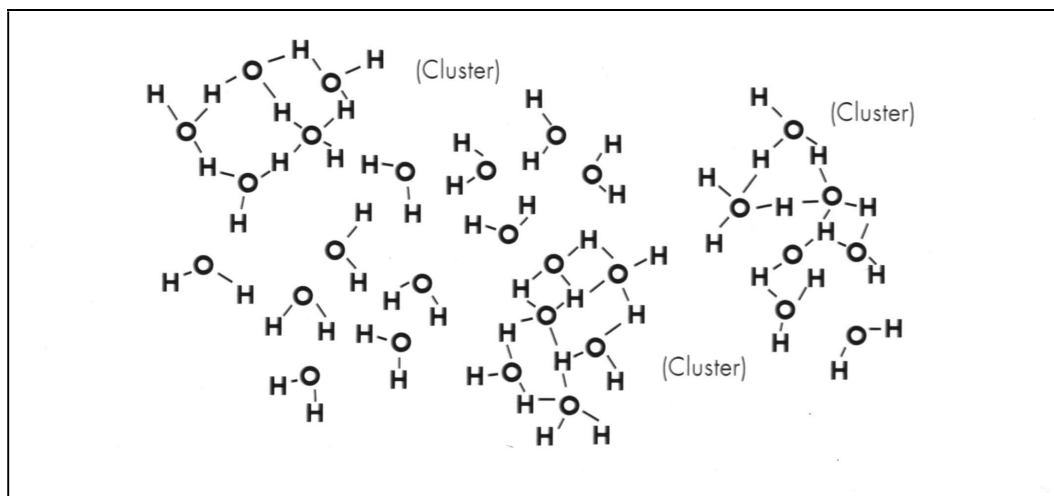

Fig. 1: Schematic outline of clusters in liquid water.

Water is a perfect dissolving agent. This is due to the high degree of dipole movement (Fig. 2 - datasheet 1.3.2) which leaves the water molecule negatively charged, thus becoming surrounded by a ring of hydrates.

## Basics - Water

Water molecules combine readily with mineral salts, and bond easily with metal ions - collectively referred to as 'Aqua-ions' (Fig 3). Generally speaking, 'Aqua-ions' are dissolved salt or metal ions. Anions, (Carbonates - Chlorides - Sulphates) are ions that have broken away from metal-ions.

When water is found to contain calcium, it is not immediately possible to determine whether it is a result of dissolved gypsum, limescale or other salts.

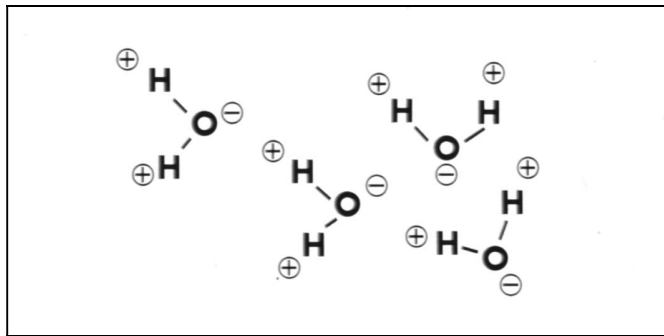

Fig. 2: A water molecule as a dipole

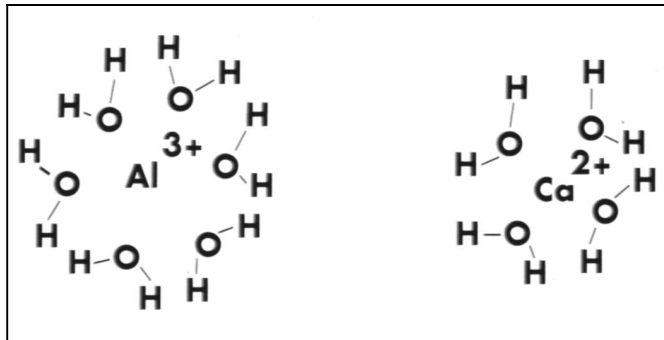

Fig. 3: Water molecules surrounded by cations (so called "Aqua-ions").

Water found in nature is never "pure". It always contains various salts and gases. The dissolved salts are known as "hard water salts" or "hardened salts".

These salts are of vital importance to Man's health and well-being. (For further information, reference should be made to specialist's health literature).

Although "Hard water" is beneficial to Man's health, it can be very damaging to pipelines and connected equipment.

The degree of calcium, magnesium, sulphates and chlorides dissolved in water is described in terms of degrees of "Total Hardness" (i.e. d.H.° = German Hardness).

The degree of carbonates dissolved in water results in the "Temporary Hardness" whereas sulphates and chlorides provide the "Permanent Hardness".

Temporary Hardness + Permanent Hardness = Total Hardness



## Precipitation of the Hardness

### Precipitation of Temporary Hardness

The dissolved temporary salts of calcium and magnesium found in water are only precipitated when the water contains a sufficient amount of carbon dioxide (dissolved CO<sub>2</sub>). When the CO<sub>2</sub> equilibrium is disturbed (i.e. increasing temperatures, sudden pressure changes etc.) the carbonates begin to precipitate.

Examples showing the precipitation of Calcium and magnesium due to increased temperature:

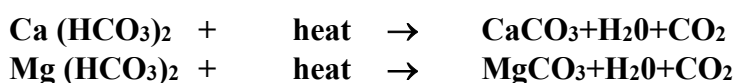

The above equations clearly indicate that bicarbonates are transformed from a soluble state into an insoluble state which leads to limescale precipitation.

This transformation is initiated at a temperature of approx. 55° C and further temperature increases lead to an acceleration of the process. At 100° C all carbonates are completely precipitated, and the water can no longer be described as containing temporary hardness.

### Precipitation of Permanent Hardness

The precipitation of sulphates and chlorides only occurs when conductivity increases, or the saturation point is exceeded. Most commonly, this is the case when water is evaporated, either naturally or through heating.

### Precipitation of Total Hardness

The following examples illustrates the variation of the amount of temporary and permanent hardness in water:

Hardness	Water sample A	Water sample B
Temporary	15° d.H.	21° d.H.
Permanent	13° d.H.	3° d.H.
Total	28° d.H.	24° d.H.

Water sample A has the highest total hardness (28° d.H.) and consists of approx. the same amount of temporary and permanent hardness.

Water sample B has a smaller total hardness (24° d.H.), but a high amount of temporary hardness.

Following this, water sample B will precipitate more limescale than water sample A.

**NB: The total hardness is not always indicating the degree of limescale build-up.**

## Precipitation of the Hardness

The results of Aqua Unique® Magnetic Water Treatment

Magnetic water treatment primarily affects temporary hardness (i.e.  $\text{CaCO}_3$  or  $\text{MgCO}_3$ ). If the temporary hardness is not less than approx. 50 % of the total hardness, magnetic water treatment will be very effective in solving the limescale problems. If the permanent hardness is greater than 50 %, a specific water analysis is required in order to decide the effectiveness of the magnetic water treatment method.

In virtually every domestic water supply, suffering from limescale problems, the temporary hardness is the source of the problem. No further investigations are necessary before installation of the magnetic water treatment system.

Problems caused by permanent hardness are most common in processed waters (i.e. cooling-towers, chemical industry, petrol/oil industry etc.). The problem also occurs in ground bores near the sea which contain high levels of sulphates and chlorides. If there are any doubts surrounding the effect of magnetic water treatment, a specific water analysis is required in order to decide if a satisfactory effectiveness can be achieved.

## Limescale Problems

Magnetic water treatment can be particularly effective in cases where water contains a substantial amount of carbonates (temporary hardness) in relation to sulphates and chlorides (permanent hardness). This is the case in most domestic water supplies. Limescale problems seldom occur in instances where water contains small amounts of carbonates.

High energy consumption, reduced efficiency, and premature replacement of equipment

Problems such as high energy consumption and poor efficiency, caused by limescale build-up in heating and cooling processes equipment, can amongst others be experienced in:

- Water Heaters
- Plate Heat Exchangers (PHE's)
- Condensers
- Air-conditioning
- Steam Vessels
- Circulation Pumps
- Booster Pumps
- Cooling Towers
- Cooling Circulation systems
- High Pressure Cleaners (hot water)
- Industrial Coffee/Hot Drinks Machines
- Steam Ovens
- Steam Cookers
- Washing Machines

In addition to higher energy consumption and poor efficiency, limescale build-up may also lead to premature maintenance and renovation (i.e. acid-cleaning, early replacement of parts etc.). Often even total replacement of equipment may be necessary.

Equipment that is especially vulnerable to hard, marble-like limescale deposits include:

- Electric Heating Elements
- Heating Coils
- PHE's plates
- Cooling Pipes/Coils
- Cooling Equipment
- Mixing Valves

Furthermore, limescale blockages can lead to pressure loss and water supply problems, as well as the replacement of pipelines, valves, pumps etc.

For further information on application possibilities, refer to datasheets 1.4.1.....

## Magnet Energy Fields

Magnetic fields only effect particles or elements which have a positive or negative electric charge.

Aqua Uniques' magnetic water treatment units are equipped with high quality, permanent magnets - Neodym. In comparison to other types of well known and commonly used magnets (i.e. Alnico or Barium-Ferrite), Neodym magnets have, to date, the greatest known energy retention ability ( $\text{kJ/m}^3$ ) and remanence (magnetism = Gauss).

Magnet	Energy retention ability ( $\text{kJ/m}^3$ )	Remanence (Gauss)
NEODYM / VACODYM	approx. $250 \text{ kJ/m}^3$	11,500 Gauss
Alnico	approx. $36 \text{ kJ/m}^3$	11,500 Gauss
Barium-Ferrite	approx. $25 \text{ kJ/m}^3$	3,650 Gauss

*Comparison of Neodym / Vacodym`s' energy retention ability and remanence with commonly used magnets.*

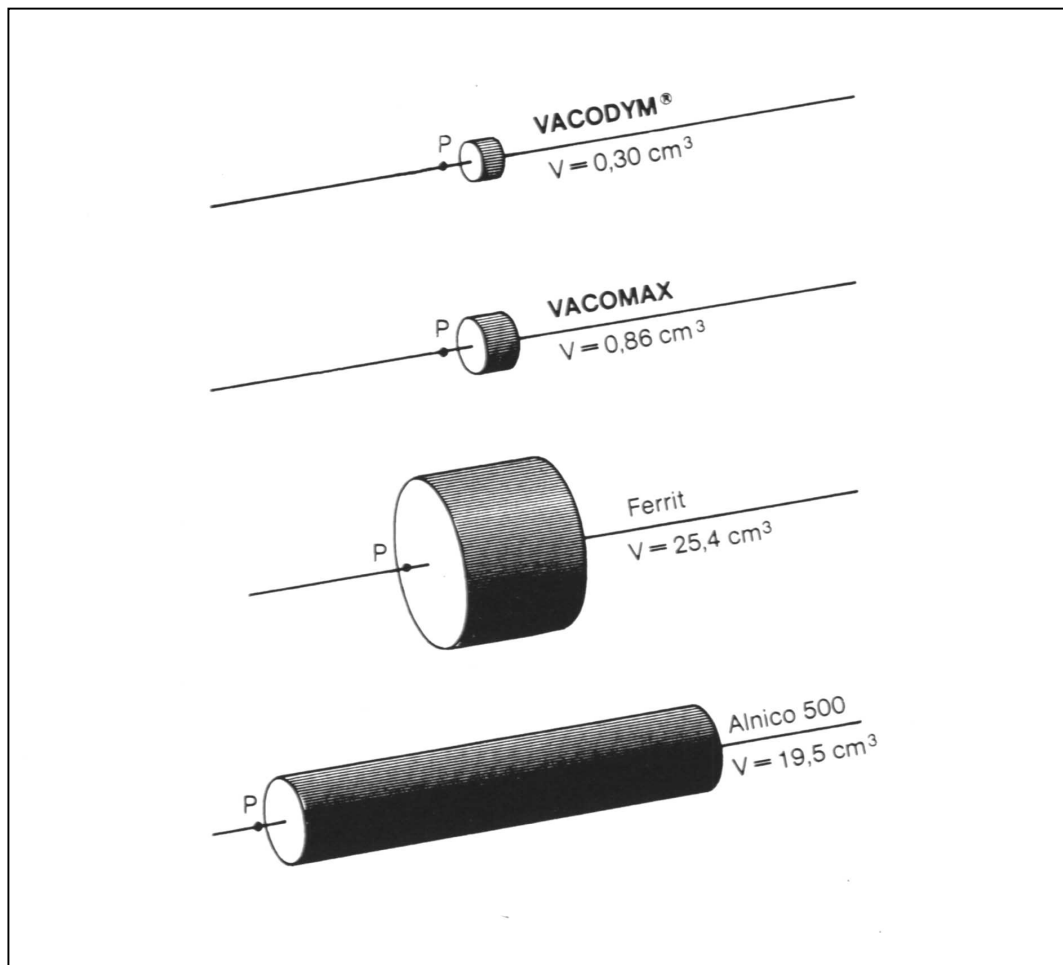

*Fig 4 - Each of the magnets provides the same energy force ( $100 \text{ mT} = 1,000 \text{ Gauss}$ ) at point P.*

*As the diagram illustrates, the NEODYM / VACODYM magnets provides the greatest magnetic energy in relation to it's volume (V).*

## The Magnetic effect upon Water

Magnetic fields have a north and a south pole. As water passes through a magnetic field at a certain angle and flow rate, it is possible to take advantage of a natural force - the so-called "Lorenz Force".

### The Lorenz Force

The effect of the Lorenz Force is described by the following equation:

$$F = \pm Q (V \times B)$$

where:

<b>F</b>	=	<b>Lorenz Force</b>
<b>Q</b>	=	<b>Charge of ions</b>
<b>V</b>	=	<b>Flow rate</b>
<b>B</b>	=	<b>Magnetic induction</b>

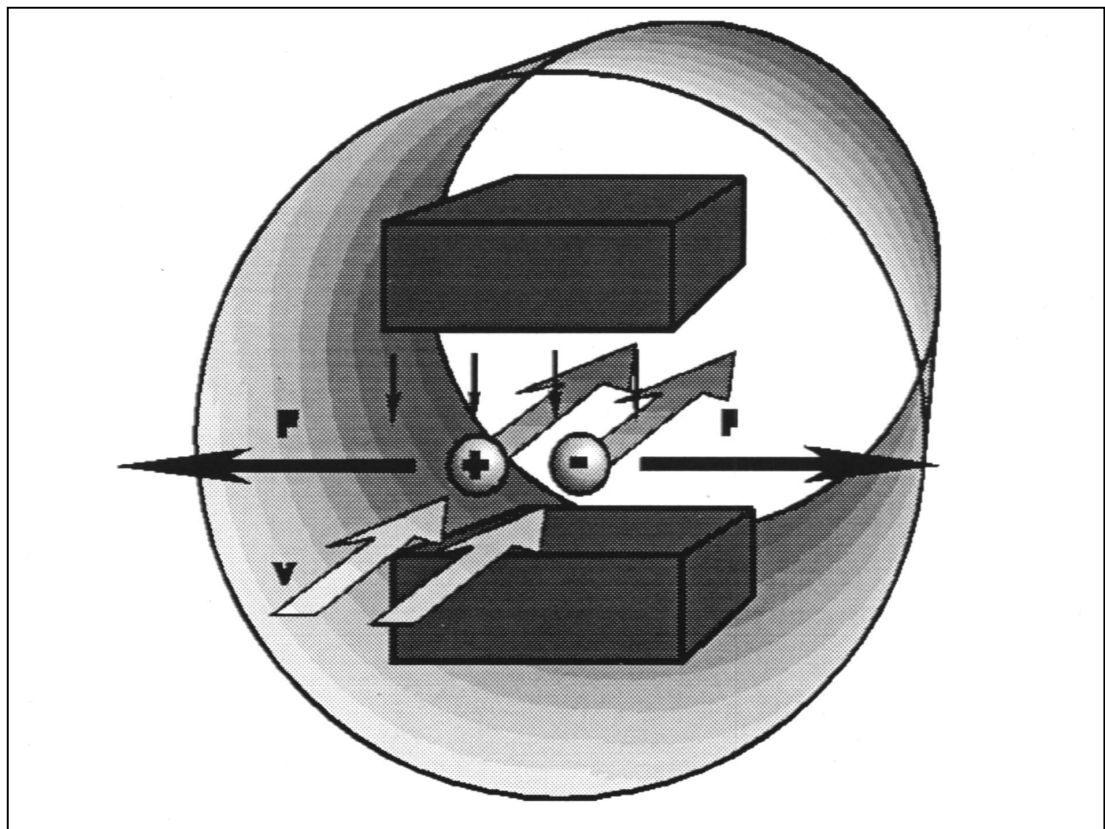

Fig: 6 The effect of a magnetic field upon positive or negative charged particles - the Lorenz Force.

### How Magnetic Water Treatment operates using the Lorenz Force

As water flows through the specially arranged Neodym magnets in a magnetic water treatment unit, different frequencies are produced. These frequencies coincide with the frequencies of the water molecules, causing them to vibrate - resonance occurs separating the water molecules from the micro-particles. This effect is known as the Lorenz Force. The results of the Lorenz Force are described on datasheet 1.3.9.

## The molecular change of $\text{CaCO}_3$ through the magnetic water treatment method

### Preventing limescale build-up

**M**icro-particles, which exist in water, would normally be the ideal alternative 'host' for the dissolved minerals in the water, but they are surrounded by water molecules. (Fig 1.) Water molecules surrounding the micro-particles. Calcium particles are attracted to a permanent surface, i.e., pipe walls, heating surfaces etc.

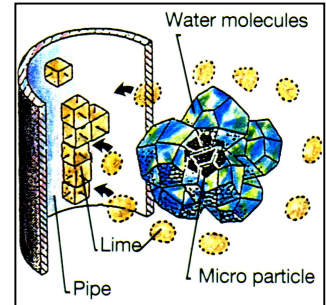

**W**ater, passing through the specially aligned polarity of the sealed Neodym magnets used in the magnetic water treatment units, becomes transformed. Resonance causes the separation of the positive and negative charged water molecules and releases the previously surrounded micro-particle (Fig. 2).

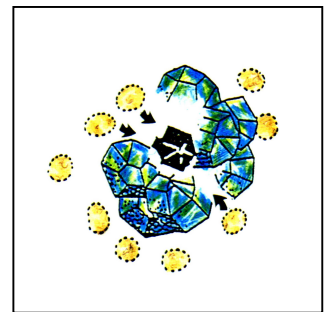

**T**he micro-particle now becomes the ideal 'host' for the loose calcium particles, allowing them to adhere to it, opposed to rough or heated surfaces (Fig. 3). These new micro-crystals will now prevent the build-up of calcium upon calcium - the primary cause of limescale build-up.

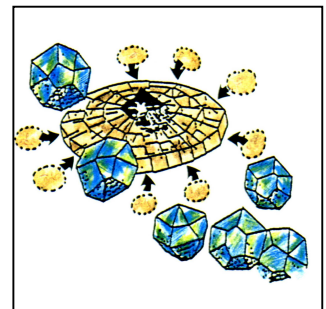

### Removal of existing limescale deposits

These 'host' micro-crystals (Fig. 3) will now circulate within the pipeline system ensuring free calcium particles adhere to them and no longer join up with each other. They will also assist existing limescale deposits to become porous, break up into minute fragments and float out with the water in suspension.

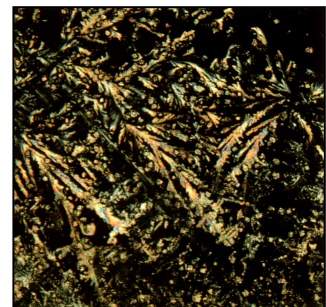

### Proving the science - crystallisation test

As water evaporates it is possible to observe the Crystallisation of the  $\text{CaCO}_3$  through an electronic microscope. *Picture 4.* shows the crystallisation before the magnetic water treatment.

*Picture 5.* shows the crystallisation after the treatment. Clearly the  $\text{CaCO}_3$  changes from one crystalline structure to another.

The molecular change of  $\text{CaCO}_3$  through the use of the magnetic water treatment method

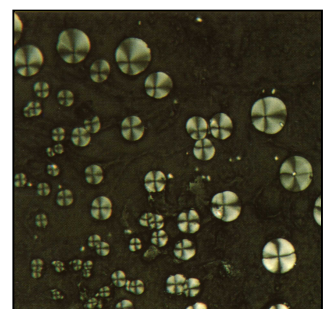

## Savings and advantages following the installation of an Aqua Unique® system

### **Pipelines**

#### **New Pipelines:**

New pipes remain free from limescale deposits, resulting in a considerably extended life expectancy of the pipeline installation. The Aqua Unique® magnetic water treatment system reduces both surface and turbulence corrosion, while hastening the formation of a protective coating against corrosion within the pipes (see data sheet: Corrosion).

#### **Existing Pipelines:**

Existing limescale deposits become porous, break up into minute fragments and are flushed out of the pipeline with the water in suspension. Rust and other corrosive compounds can also be dissolved if they are mixed with limescale. A large part of the dissolved lime and rust deposits are commonly precipitated, i.e. in the water heater from which they can easily be washed out. Immediately following the installation of the water treatment system, regular wash out of the water heater and rinsing of filters, magnetic strainers and aerators is recommended weekly. These procedures should be carried out for a minimum period of 2-3 months. These procedures may have to be carried out for a longer period of time depending on the quantity of limescale and rust. When the pipelines are free from deposits, the formation of a protective coating against corrosion begins.

### **Water Heaters - Storage/Instantaneous**

#### **New Water Heaters:**

Assuming a maximum temperature of 70° C, new water heaters will remain free from limescale deposits on the heating coils/elements and tank walls. A minimal amount of lime may be precipitated as sludge. Pressure valves and mixing valves also remain free from limescale, thus avoiding overpressure and adjustment problems. This results in a safe and continuous hot water supply. At temperatures over 70° C, the amount of lime sludge will increase accordingly, however the heating coils/elements and tank walls will continue to remain free from limescale build-up. The results are high energy savings and considerably extended life expectancy.

#### **Existing Water Heaters:**

Existing limescale deposits from the heating coils/elements and tank walls will become porous and peel off. The resulting precipitated sludge can easily be removed, either by filtration or simply by washing out the tank. Due to the insulation effect of the limescale, the removal of the limescale build-up results in energy savings and a considerably extended life expectancy.

## Savings and Advantages following the installation of an Aqua Unique® system

### Plate Heat Exchangers (PHE's)

#### **New Plate Heat Exchangers - Temperatures < 70° C.:**

Assuming a maximum temperature of, new plate heat exchangers remain free from limescale build-up. The installation of a Aqua Unique® magnetic water treatment system, will extend the maintenance interval of the PHE by at least 3-4 times that of the norm. In addition, the plates can commonly be cleaned with water jet and brush instead of the typical acid-cleaning. Costs related to reduced heat transfer, acid-cleaning, servicing and maintenance are reduced considerably.

#### **New Plate Heat Exchangers - Temperatures > 70° C.:**

The precipitation of lime-sludge starts at temperatures over 70° C. In systems with little or no water circulation, the lime-sludge can become lodged in the bottom of the exchanger plates and if not rinsed out the sludge will eventually adhere to the plates.

Even under such circumstances the installation, of an Aqua Unique® magnetic water treatment system, will extend the maintenance interval of the PHE by at least 3-4 times that of the norm. In addition, the plates can usually be cleaned with a brush and water jet instead of the typical acid-cleaning.

PHE's with relatively powerful circulation, will flush the lime-sludge through the plates, and into either a buffer tank, storage water heater or a filtration unit.

#### **Existing Plate Heat Exchangers:**

Existing lime deposits can be softened and removed from blocked plate heat exchangers, assuming a good degree of water circulation exists, and the temperature is below 65-70° C. However, in most cases, we recommend that the PHE is cleaned, prior to the installation of a magnetic water treatment system. This is due to the physical problems in flushing out the limescale/stone deposits through the very small gaps between the plates.

Concerning extended cleaning intervals, we refer to the information above on new PHE's.

#### **NB - Plate Heat Exchangers:**

The following cases can reduce the efficiency of the magnetic water treatment:

- In cases of superheating (i.e., when thermostatic valves are ineffective or malfunctioning the system cannot provide a 100 % remedy.
- In cases of low circulation combined with high temperature (i.e., superheating) the system can not provide a 100 % remedy.

Superheating: Total precipitation of the hardness, due to temperatures up to 100° C, may result in the magnetic water treatment, not being 100 % effective.

However, the precipitate will be of such a porous nature, that cleaning intervals commonly can be extended to 2-4 times that of the norm. In addition, the plates can commonly be cleaned with a brush and water jet instead of the typical acid-cleaning.

PS: In order to completely solve such problems, a total re-design of the system is often necessary.



## Savings and Advantages following the installation of an Aqua Unique® system

### **Pumps**

Pumps that remain free from lime-scale build up have a considerably extended life expectancy. (i.e. reduced maintenance, better efficiency, reduced energy consumption). Avoiding limescale build-up in the pump, reduces pressure loss problems considerably.

### **Washing Machines**

Heating elements remain free from lime deposits, while existing lime deposits are broken down and precipitated in to the lint filter. The benefits include more efficient energy usage and a considerably longer life expectancy. In addition, due to the fact that the Aqua Unique® system reduces surface tension, costs related to washing, rinsing and softening products, can be reduced by up to 30 %.

## Consumer Guide

Quality Remember

### **What is magnetic water treatment?**

It is not a limescale remover as is generally believed. Limescale can only be removed from water, either by softening processes, or by the addition of chemicals - both of which in most countries are forbidden in drinking and household water supplies. Instead, SOLVIN magnetic water treatment changes the molecular structure, so that mineral salt and limescale no longer leave deposits in the piping system but remain in a 'broken down' state. At the same time the electrical current on the water surface is reduced, providing advantages in terms of both maintenance and economy.

### **Limescale Stains/Deposits**

As water evaporates, a build up of calcium and mineral salt deposits will occur. However, after installation of a SOLVIN water treatment unit, the deposits will no longer be hard and unmanageable, but porous and easily removable. A rough household sponge or brush is recommended.

NB.: Cleaning should be performed at one-to-two-week intervals. Otherwise, the reaction of oxygen with the 'softened' limescale deposits, may once again cause it to harden and become difficult to remove.

### **Taps, Mixers, Shower jets and Hot water tanks etc.**

Over time, the build up of limescale in shower jets and tap filters, can result in a total blockage. It should be noted that during the months immediately after the installation of a SOLVIN water treatment unit, a large amount of previously limescale build-up within the piping system, is loosened - the result is that filters may need to be cleaned more often than usual during this period. However, under general conditions, we recommend that cleaning takes place once every 14 days.

NB.: To maximise the efficiency of the SOLVIN water treatment unit, we recommend that taps, shower jets, WCs etc. are in good condition and free from leakages.

### **Washing and Dish-washing machines**

The installation of a SOLVIN magnetic water treatment system can result in savings of up to 30 % of the cost of washing and rinsing products. In addition, your machine will have a longer life expectancy, due to the fact that the convector is kept clean from limescale deposits.

NB.: Filters should be cleaned regularly, in particular, during the months immediately after installation of the SOLVIN system.

### **Coffee Machines**

In general, the SOLVIN system will have a beneficial effect on your coffee machine, reducing limescale build-up, and consequently the need for cleaning and maintenance. However, machines with powerful heating elements, and those that remain warm for a long period after use, have shown to reduce the effectiveness of the magnetic water treatment.

### **Kettles, Pots and Pans**

As with Coffee Machines, the effectiveness of the SOLVIN system is dependent upon the degree and duration of heating. Rinsing your kettle, pots and pans with cold water after use, will make any limescale build-up porous and easily removable.

### **Bathroom tiles / fittings etc.**

The installation of a SOLVIN system will reduce the cleaning and maintenance of your bathroom tiles and fittings.

### **Avoiding costly repairs**

A SOLVIN magnetic system will help you to avoid costly repairs and maintenance in the piping installations, and hot water tank in your home. The treatment also leaves a protective coating in your piping system, which thereby prevents corrosion damage.

### Circumstances reducing the Efficiency of the Aqua Unique® Magnetic Water Treatment

As with all physical phenomena, the efficiency of the magnetic water treatment is not everlasting. For example, if water is heated and stored in a tank, the water temperature slowly drops until the water reaches its original temperature. To keep the water temperature constant, it has to be kept heated.

A similar phenomenon is produced by the Aqua Unique® magnetic water treatment system. Magnetically treated water loses some of its positive attributes when stored for several days (3-5 days depending on water quality and temperature). To maintain these positive attributes for a longer period, the water must be treated again. In almost every normal drinking water installation, water is consumed within a short period, normally within approx. 8-24 hours. This causes no problems to the efficiency of the magnetic water treatment method.

*It should be noted that the efficiency of the water treatment is not 100 % ineffective, due to these disturbing physical factors - on the contrary excellent results can be achieved. A further argument in favour of this technology, is the fact that it works 100 % without the use of chemicals, sacrificial anodes or external power.*

### Reduced efficiency

**The following physical factors can have varying effects upon the efficiency of the magnetic water treatment:**

1. Heavy turbulence or external magnetic power (i.e., pumps)
2. Storage at high temperature for long periods of time (i.e., storage water heater)
3. Pressure drop (i.e. vacuum- or booster/pressure pumps)
4. Oxidation (i.e., cooling towers)

*For this reason, an additional magnetic water treatment unit should be installed to the pressure side of the pump to assure the highest possible efficiency, i.e.:*

- Cooling circulations
- Hot water circulations
- Booster stations
- Cooling towers

### Satisfactory results with reduced efficiency

Even with reduced efficiency, due to the above-mentioned physical factors which occur following the water treatment, satisfactory results can be achieved in the following:

- Cleaning/Maintenance intervals are increased considerably
- Waterjet/high pressure cleaning is possible as opposed to acid-cleaning
- Acid-cleaning is reduced or becomes unnecessary

## Product Information

### Aqua Unique® - AU CW – Domestic unit

Water temperature max. 40° C

Model	Connection		Capacity l/min	
	DN	Inch	min.	Max.
AU 20 - 35 CW	20	¾	0,5	35

### Aqua Unique® - AU HW – Domestic / Industrial units.

Water temperature max. 100° C

Model	Connection		Capacity l/min	
	DN	Inch	min.	Max.
AU 15 - 6 HW	15	½	0,1	8
AU 15 - 15 HW	15	½	2,5	15
AU 20 - 45 HW	20	¾	0,5	45
AU 25 - 65 HW	25	1	0,5	65
AU 32 - 135 HW	32	1¼	19	135
AU 40 - 245 HW	40	1½	25	245
AU 50 - 385 HW	50	2	40	385

### Aqua Unique® - AU EFL – Industrial units

Water temperature max. 100° C

Model	Connection		Capacity l/min	
	DN	Inch	min.	max.
AU 65 - 550 EFL	65	2½	150	550
AU 80 - 820 EFL	80	3	225	820
AU 100 - 1100 EFL	100	4	305	1100
AU 125 - 2810 EFL	125	5	555	2810
AU 150 - 3700 EFL	150	6	1055	3700
AU 200 - 6340 EFL	200	8	1810	6340
AU 250 - 10580 EFL	250	10	3025	10580
AU 300 - 15875 EFL	300	12	4535	15875
AU 350 - 19570 EFL	350	14	5590	19570

## Product Information

### Aqua Unique® - AU MPS Magnetic particle Strainer

Model	Connection	
	DN	Inch
AU 15 MPS	15	½
AU 20 MPS	20	¾
AU 25 MPS	25	1
AU 32 MPS	32	1¼
AU 40 MPS	40	1½
AU 50 MPS	50	2
AU 65 MPS	65	2½

### Product Information's:

**Standard Models:** AU CW / AU HW  
Connections: Stainless steel  
Inner pipe: Stainless steel, type SAF 2304  
Magnet tubes: Titanium  
Red cover: PVC  
Magnets: Neodym 35H, Coating NICUNI

**Standard Models:** AU EFL  
House: Galvanised pipe  
Flanges: DN 65 - DN 100 - DIN 2576B  
DN 125 - DN 350 - DIN 2633  
Magnet tube: Stainless steel  
Magnets: Neodym 35H, Coating NICUNI

### Standard Sales Conditions:

Delivery time: Standard Models AU CW / AU HW: 3-4 weeks  
Standard Models AU EFL: 4-6 weeks  
Stainless steel Models: 6-8 weeks  
Magnetic Particle Strainers AU MPS: 3-4 weeks  
Models with special standards: Delivered on request

Packing: All products will be delivered in standard packing.

Reservations: Against changes in rate of exchange, material costs, labour etc.

## Small AU-Unit cut through



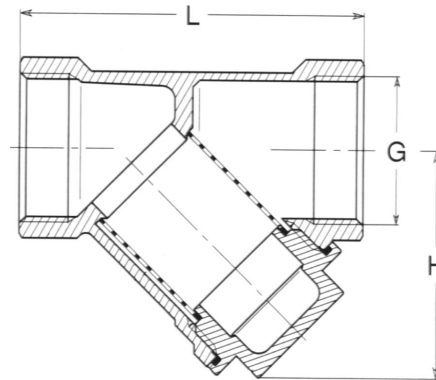

Magnetic particle strainer for protection of the sealed Neodym magnets in the Aqua Unique® magnetic water treatment unit. The AU MPS provides a unique protection against blockages in the magnetic water treatment unit, when treating water containing magnetite, iron, rust and limescale particles.

### Aqua Unique® - Magnetic Particle Strainer - AU MPS

Water temp. max. 100° C

Model	Connection (G)		Capacity		Dimension	Weight
	DN	Inch	max. l/min.	max. m³/h.	L x H	Kg
AU 15 MPS	15	½	15	0,9	53 x 36	0,2
AU 20 MPS	20	¾	45	2,7	65 x 42	0,3
AU 25 MPS	25	1	65	3,9	77 x 51	0,5
AU 32 MPS	32	1¼	135	8,1	91 x 63	0,7
AU 40 MPS	40	1½	245	14,7	102 x 70	1,0
AU 50 MPS	50	2	385	23,1	118 x 87	1,5
AU 65 MPS	65	2½	550	33,0	150 x 108	16,0

### Product Information:

#### Materials:

House:	DN 15 - DN 50 : Bronze. DN 65 : Cast iron.
Strainer:	Stainless steel.
Magnets:	Barium Ferrite/Alnico.

#### Technical Specifications:

Working pressure:	24 bar.
Connection:	DN 15 - DN 50 : Female thread, (DN). DN 65 : Flanges, DIN 2576B.
Installation:	Vertical or horizontal, direction of flow = arrow →

#### Maintenance:

Cleaning:	To prevent pressure loss, filter & magnets <u>should</u> be cleaned.
-----------	--

## Pressure loss curves AU MPS

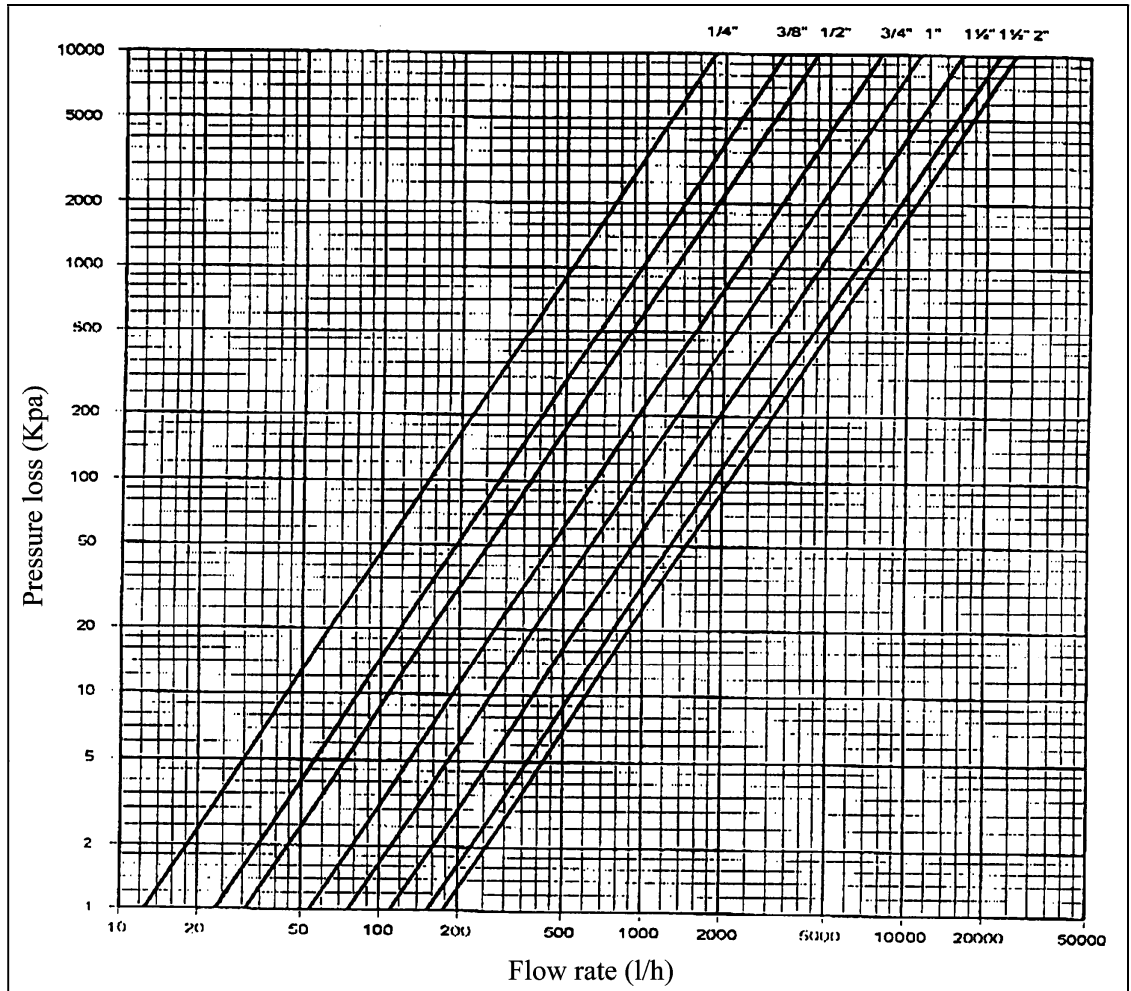

*The curve is illustrating the pressure loss on Aqua Unique® Magnetic Particle Strainers.*